

# Laserline LDM

## The Compact Class for Diode Lasers

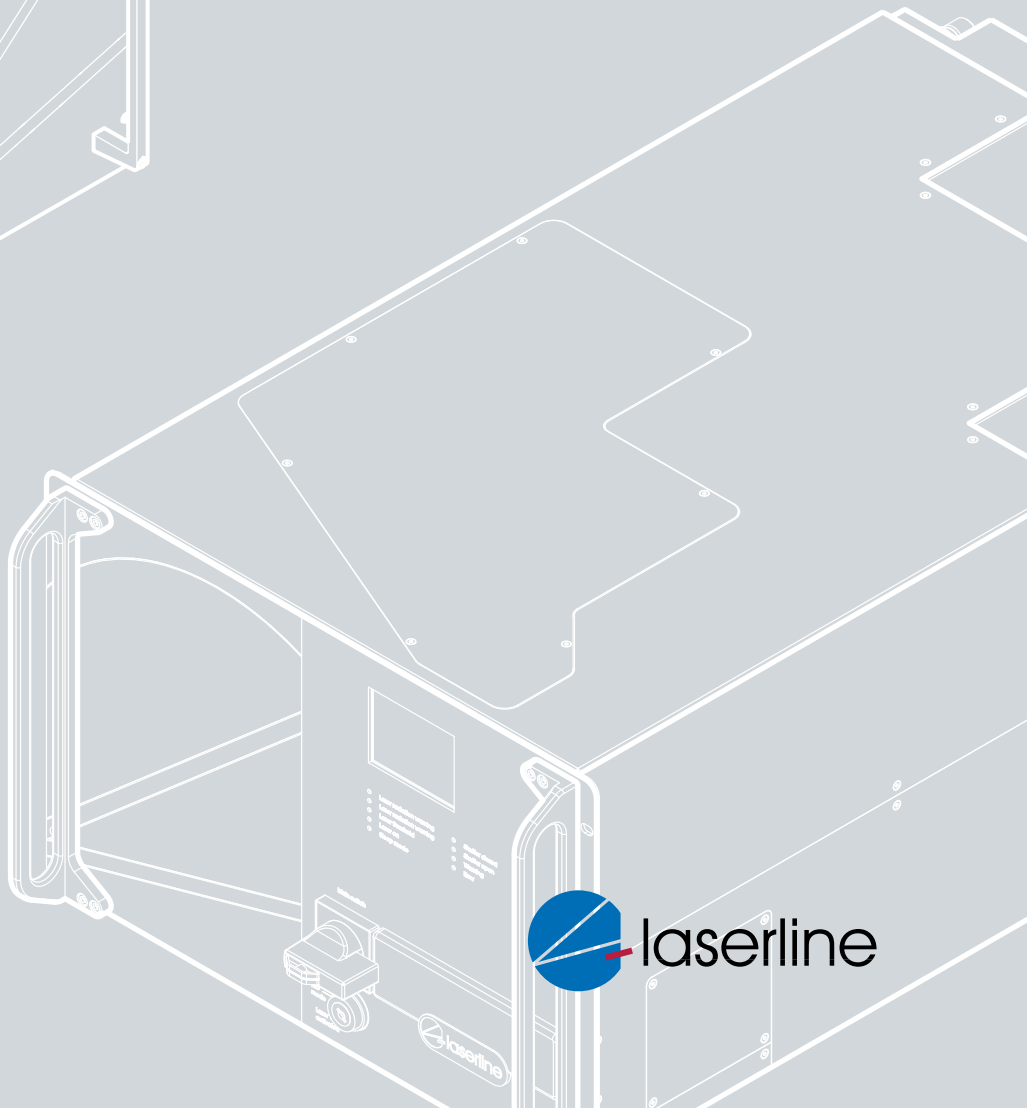
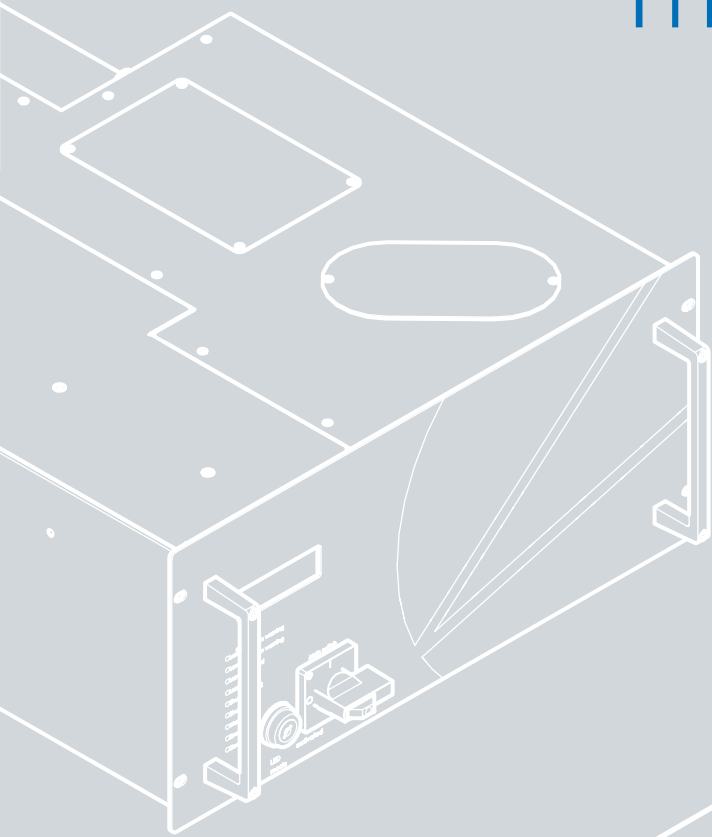

# Compact, Powerful and Reliable in any Application

## Compact

The 19-inch rack mount technology offers a significant simplification of the laser integration in machines or systems. The LDM module combines the laser head, the power supply of the diodes, the controller for monitoring, as well as the cooling system. The innovative, small footprint design allows the LDM diode laser to be easily integrated within the production area, for example inside a standard cabinet, the processing station or even below the conveyor belts of production lines. The laser requires no additional space and therefore is perfect for OEM applications.

## Powerful

With an increase in performance of the product family LDM in the 7 RU system, Laserline again sets the standard for compact high power diode lasers. The further development of the LDM technology opens up new applications with up to 8 kW laser power. The beam quality of the fiber-coupled LDM diode laser is comparable to that of a lamp-pumped solid-state laser, with a tenfold higher outlet efficiency at a fraction of the size. Very easy to use thanks to the functional, standardized signal interface that highlights our user-centered product philosophy.





Many laser operators require compact systems that also deliver high laser power. This balancing act is perfectly achieved by our diode lasers of the LDM series that set new benchmarks with their laser power of up to 8,000 W in a rack module.



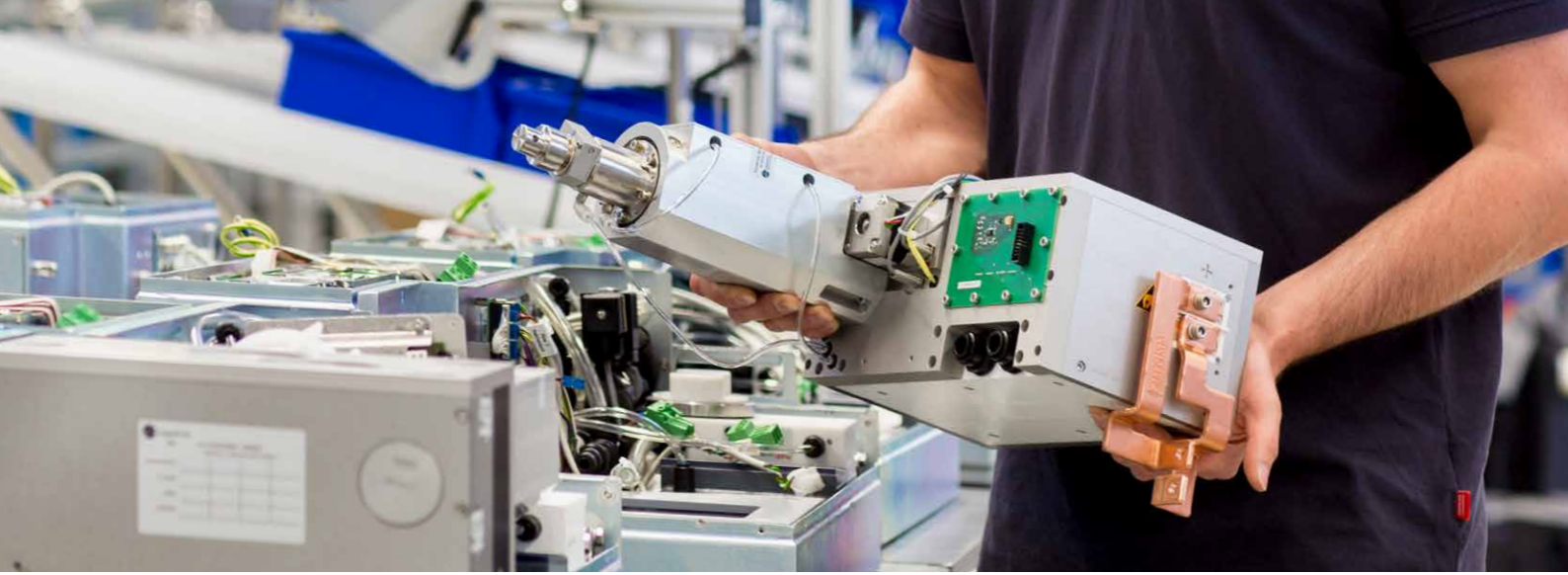

## Reliable

The LDM module is based on the proven and continually developed Laserline diode technology that has been successfully used for many years in different applications. The series is characterized by reliability and system stability. Diode lasers by Laserline are generally offered with five-year warranty on the laser diodes – optionally even longer.

### Perfect laser system for OEM applications

- > Up to 8 kW in a 19-inch rack mount
- > 5 years warranty on laser diodes
- > Beam quality comparable to Nd:YAG solid state laser
- > Ideal for welding, hardening, as well as for mobile repair welding
- > Easy integration into laser systems
- > If needed, components exchangeable in the field
- > Fiber-coupled lasers in different performance classes as required

## The application in focus

The miniaturization of the laser system leads to a significant reduction in the cost of investment and operation. LDM diode lasers therefore have significant potential not only when replacing existing laser applications, but also for conventional welding, repair or heat treatment processes.

## Independent servicing in the application

To ensure very high availability of the laser systems, users are supported worldwide by our teleservice via the Internet – around the clock. At the same time, the new system generation has been specifically designed for fast maintenance and independent on-site servicing. Thus, the essential components of the system – laser head, cooling unit as well as power supply and control unit – are quickly and easily interchangeable as modules, if necessary in the field. What's more, these sub components increase the modularity of the rack system.

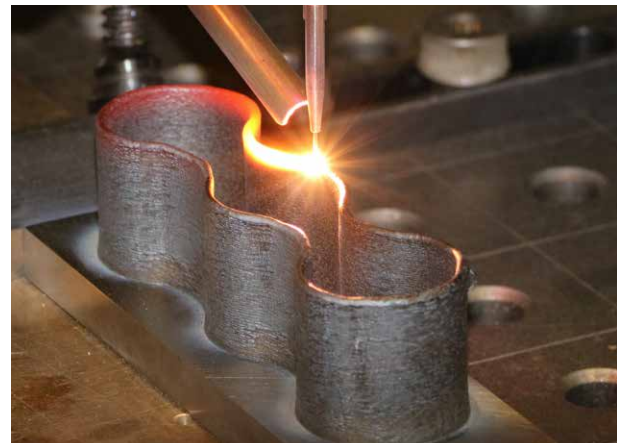

# VG5H

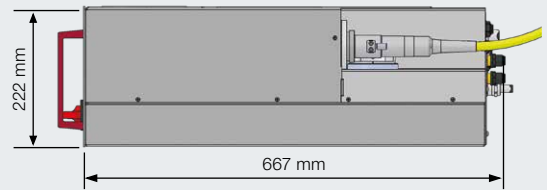
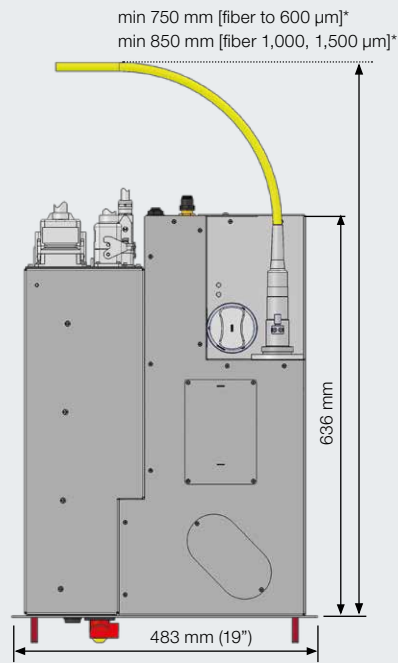
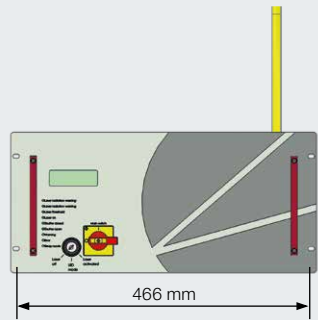

# VG7H

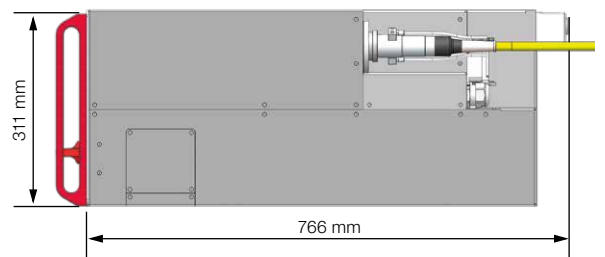
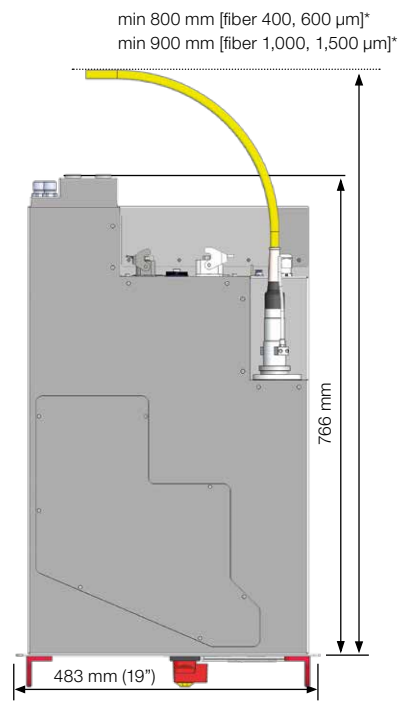
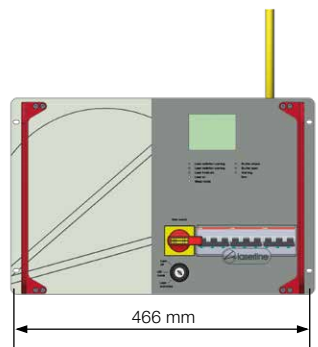

\*fix installation, no torsional stress

## LDM Series

### Optical specifications

Max. output power	1,500 W	3,000 W	4,000 W	6,000 W	8,000 W
Beam quality	20 mm mrad	30 mm mrad	40 mm mrad	60 mm mrad	100 mm mrad
	Other laser output powers available, tailored to the applications				
Optical fiber	400 µm [NA 0.1]	600 µm [NA 0.1]	400 µm [NA 0.2]	600 µm [NA 0.2]	1,000 µm [NA 0.2]
Min. focus at f = 150 mm	300 µm	450 µm	600 µm	900 µm	1,500 µm
Fiber-coupling unit	LLK-D/Auto, more types on request				
Fiber length	10 m, 20 m, 30 m, 50 m, 100 m, other lengths on request				
Power stability	<+/- 2% over 2 h				
Wavelength range	900 nm to 1,080 nm				

### Mechanical specifications

VG5H	Weight: approx. 50 kg, size: 19" rack mount, 5U (220 mm), depth 636 mm
VG7H	Weight: approx. 110 kg, size: 19" rack mount, 7U (312 mm), depth 766 mm

### Connection data

Voltage	400 - 480 V, 3 phases, PE, 50 or 60 Hz				
	210 - 230 VAC, 1 or 3 phases, PE, 50 or 60 Hz on request				
Power consumption, typically	5.8 kW	10.6 kW	12.2 kW	17.2 kW	20.6 kW
Cooling requirements, typically	4.3 kW	7.6 kW	8.2 kW	11.2 kW	12.6 kW
External inputs	Digital 24 V, analog power control 0 - 10 V, safety interlocks				

### Operating conditions

Temperature	10 - 45 °C operational, 5 - 65 °C storage
Humidity	Max. 70% @ 25 °C, non condensing
Protection rating	IP54
Safety class	Laser safety class 1 according to EN 60825-1

### Options

Interface	Profibus DP, Ethernet, RS232 (VG5H) / USB (VG7H)
Optics	Laserline optics or commercial optics for every application
Others	Teleservice, pilot laser, pyrometer, CMOS camera, software for PC, beam scanner, special wavelength for pumping applications

### Warranty and lifetime

Warranty	5 years on diode laser elements, 2 years on laser system
Diode cooling	Active for highest power density and reliability
Uptime	Typically > 99.5%

Further diode lasers are available in the series LDM and LDF with output power up to 45,000 W. Concerning functional safety, the laser conforms to DIN EN ISO 13849-1 and achieves performance level d.

#### Laserline GmbH

Fraunhofer Straße | 56218 Mülheim-Kärlich, Germany  
 Tel. +49 2630 964 0 | Fax +49 2630 964 1018  
 sales@laserline.com | www.laserline.com

#### USA

Laserline Inc. | info-usa@laserline.com

#### Brazil

Laserline do Brasil Diode Laser Ltda. | info-brasil@laserline.com

#### China

Laserline Laser Technology (Shanghai) Co. Ltd. | info-china@laserline.com

#### India

Laserline Diode Laser Technology Pvt. Ltd. | info-india@laserline.com

#### Japan

Laserline K.K. | info-japan@laserline.com

#### Korea

Laserline Korea Co. Ltd. | info-korea@laserline.com